

## Thermal device circuit breaker - TCP 0,1A - 0712107

Please be informed that the data shown in this PDF Document is generated from our Online Catalog. Please find the complete data in the user's documentation. Our General Terms of Use for Downloads are valid (<http://download.phoenixcontact.com>)



Thermal miniature circuit breaker, pluggable in screw-type fuse terminal block UK 6-FSI/C and spring-cage fuse terminal block ST 4-FSI/C

The illustration shows version TCP 2A

### Product Features

- ✓ A version with screw or spring-cage connection is used as a basic terminal block
- ✓ The reclosable thermal circuit breaker is available in ten nominal current levels ranging from 0.1 to 10 A
- ✓ Compact design
- ✓ The integrated switching function enables immediate reclosure and therefore ensures the availability of the system



### Key commercial data

Packing unit	1 pc
Weight per Piece (excluding packing)	11.17 GRM
Custom tariff number	85362010
Country of origin	Indonesia

### Technical data

#### General

Installation instructions	When mounted in rows, the nominal device current can be limited to just 80% or must be overdimensioned accordingly.
Mounting type	On base element
Color	black
Number of positions	1
Surge voltage category	II
Insulating material	PPS
Inflammability class according to UL 94	V0

#### Electrical data

# Thermal device circuit breaker - TCP 0,1A - 0712107

## Technical data

### Electrical data

Fuse	Slow-blow
Fuse type	Automatic device
Rated surge voltage	2.5 kV
Rated voltage	250 V AC
	65 V DC
Rated current $I_n$	0.1 A
Insulation resistance $R_{iso}$	> 100 M $\Omega$ (500 V DC)
Rated short-circuit switching capacity $I_{cn}$	0.6 A (250 V AC / 65 V DC)
	2.5 A (30 V DC)
Short-circuit switching capacity $I_k$	2000 A 250 V AC / UL 1077
	2000 A 72 V DC / UL 1077
Dielectric strength	3000 V AC (Actuation area)
	1500 V AC (Installation area)
Cycles, max.	6000 (At 1 x $I_n$ , low-induction)
	3000 (At 1 x $I_n$ , inductive)
	500 (At 2 x $I_n$ , inductive)
Pollution degree	2
Surge voltage category	II
Insulating material group	IIIb

### Dimensions

Height	24.4 mm
Width	8.2 mm
Depth	44.5 mm
Height NS 35/7,5	55 mm

### Ambient conditions

Degree of protection	IP40 (Actuation area)
Ambient temperature (operation)	-20 °C ... 60 °C

### Standards and Regulations

Standards/specifications	EN 60934
--------------------------	----------

### Classifications

#### eCl@ss

eCl@ss 4.0	27141116
eCl@ss 4.1	27141116

# Thermal device circuit breaker - TCP 0,1A - 0712107

## Classifications

### eCl@ss

eCl@ss 5.0	27141116
eCl@ss 5.1	27141116
eCl@ss 6.0	27141116
eCl@ss 7.0	27141116
eCl@ss 8.0	27141116

### ETIM

ETIM 2.0	EC000899
ETIM 3.0	EC000899
ETIM 4.0	EC000899
ETIM 5.0	EC000899

### UNSPSC

UNSPSC 6.01	30211812
UNSPSC 7.0901	39121411
UNSPSC 11	39121411
UNSPSC 12.01	39121411
UNSPSC 13.2	39121411

## Approvals

### Approvals

---

#### Approvals

CSA / UL Recognized / VDE Zeichengenehmigung / cUL Recognized / cULus Recognized

---

#### Ex Approvals

---

#### Approvals submitted

---

#### Approval details

# Thermal device circuit breaker - TCP 0,1A - 0712107

## Approvals

CSA 	
Nominal current IN	0.1 A
Nominal voltage UN	250 V

UL Recognized 
---

VDE Zeichengenehmigung 
--

cUL Recognized 
--

cULus Recognized 
--

## Drawings

# Thermal device circuit breaker - TCP 0,1A - 0712107

Diagram

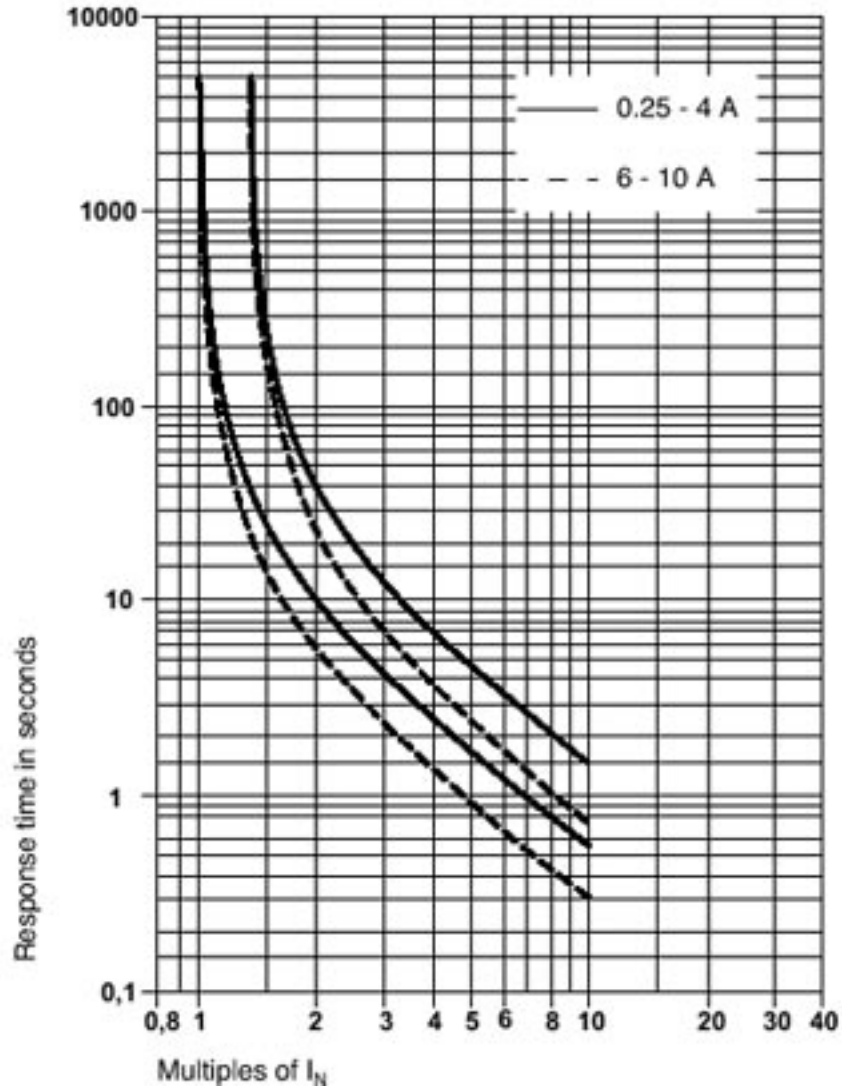

# Thermal device circuit breaker - TCP 0,1A - 0712107

Application drawing

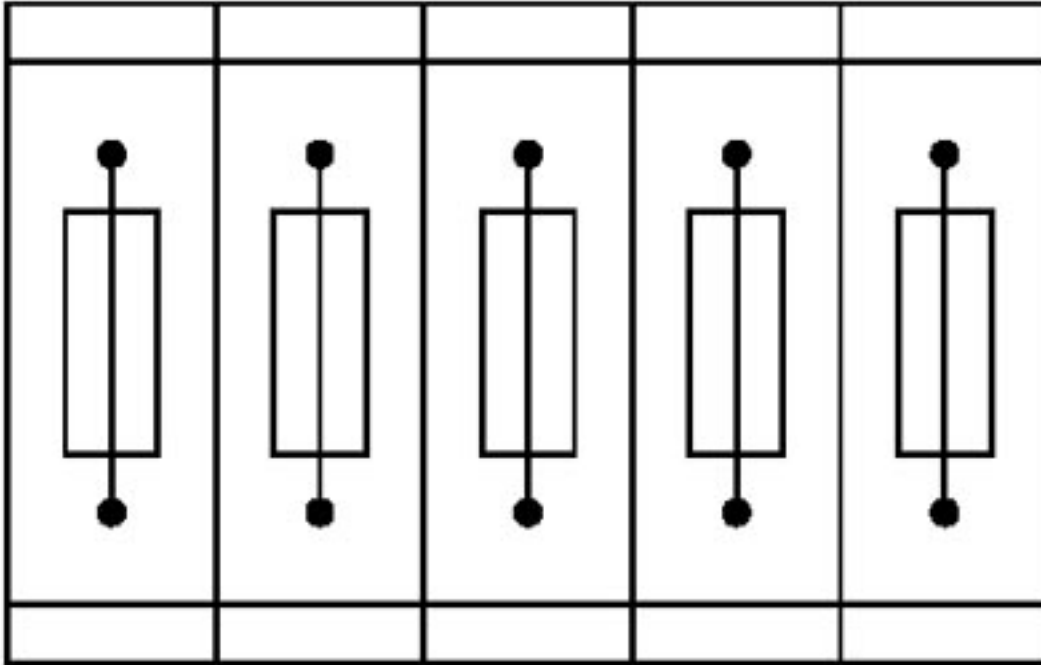

Fuse terminal blocks in interconnected arrangement,  
block consisting of 5 fuse terminal blocks

# Thermal device circuit breaker - TCP 0,1A - 0712107

Application drawing

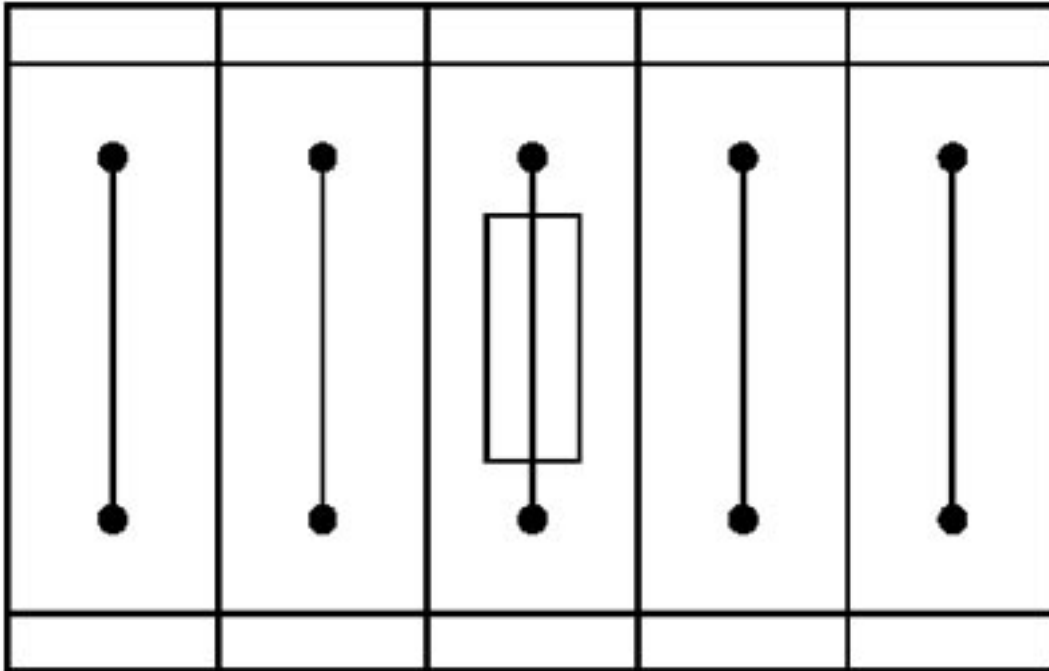

Fuse terminal block in single arrangement,  
block consisting of one fuse terminal block and 4 feed-through terminal blocks

# Thermal device circuit breaker - TCP 0,1A - 0712107

Dimensioned drawing

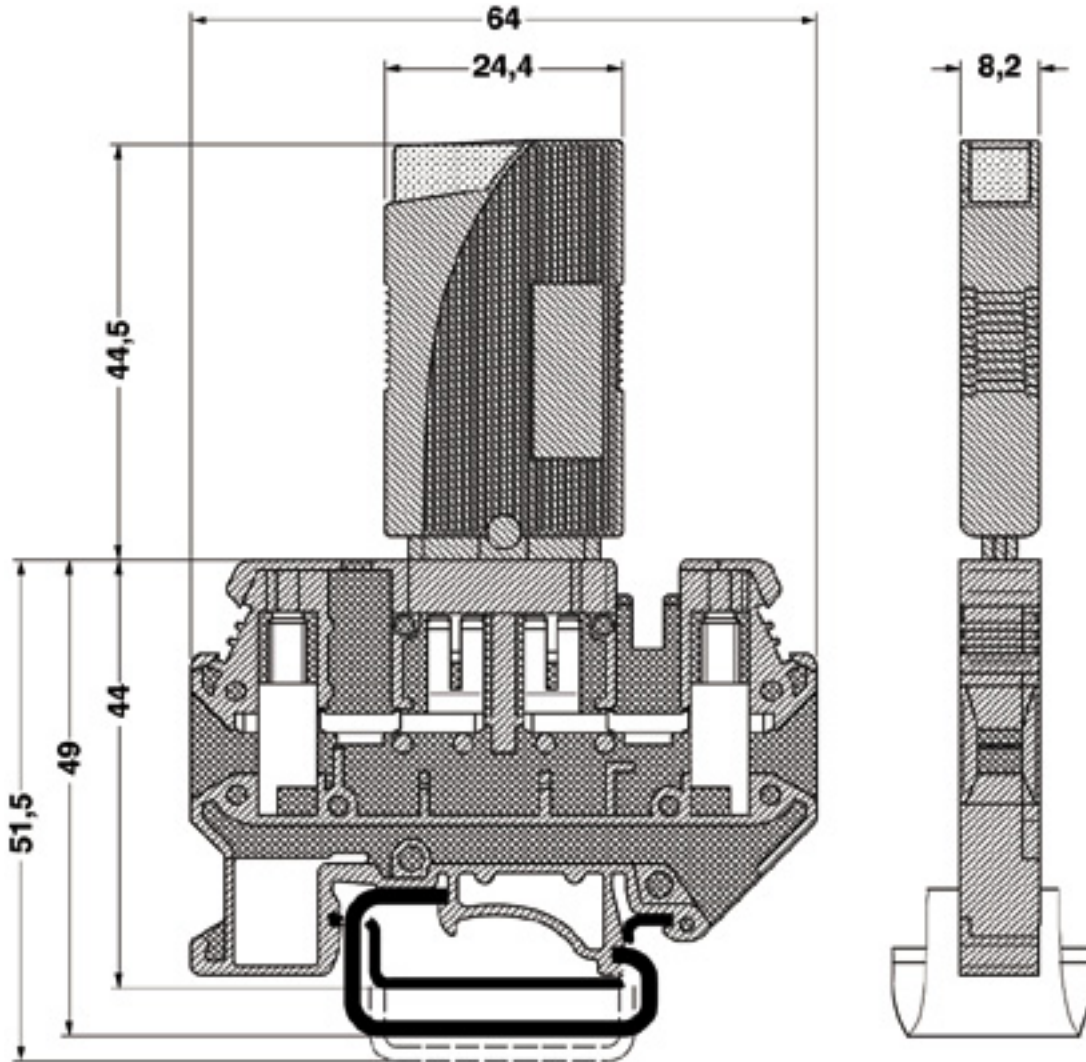



# Thermal device circuit breaker - TCP 0,1A - 0712107

Dimensioned drawing

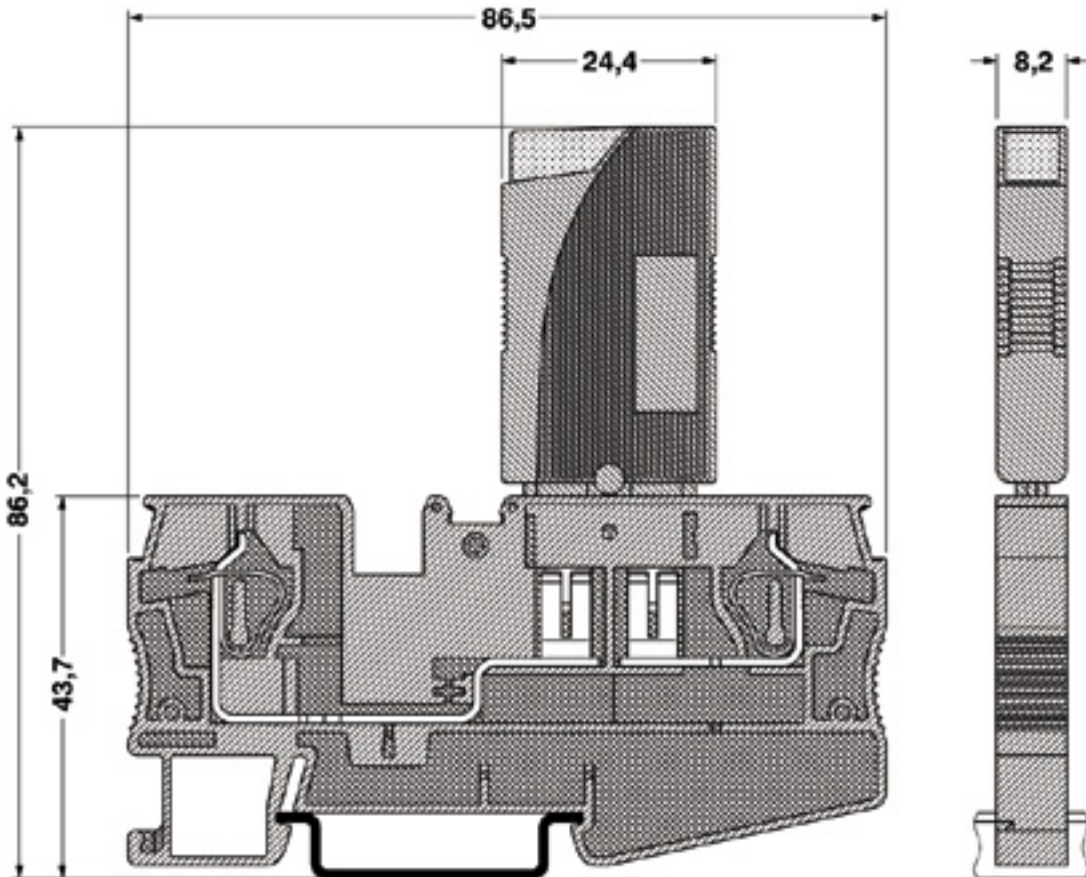

# Thermal device circuit breaker - TCP 0,1A - 0712107

Application drawing

